

Technical and Dimensional specifications of wheel block

مشخصات فنی و ابعادی ویل بلاک

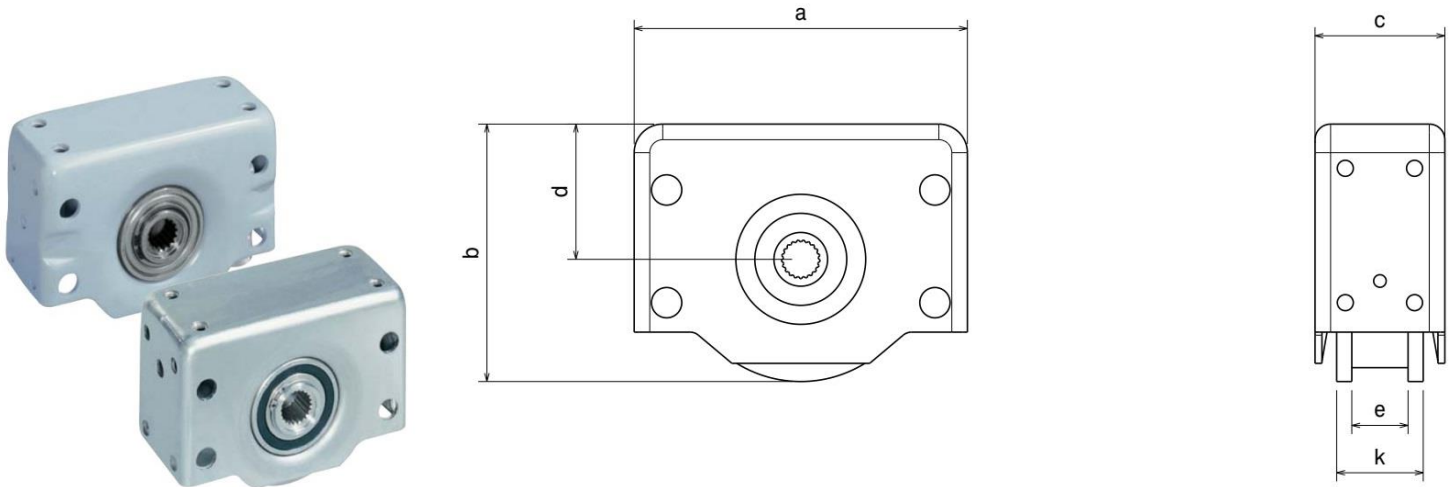

Model	Dimension (mm)						Capacity (Ton)	Weight (Kg)	Travel wheel Diameter (mm)	Working group
	a	b	c	d	e	k				
RS 125	220	148	98	85	60	68	3.5	8	125	M5
RS 160	275	187	110	107	60	75	5	15	160	M5
RS 250	385	281	150	156	65	100	9	40	250	M5
RS 315	470	350	180	192	65	110	12	65	315	M5
RS 400	580	440	210	240	80	140	18	153	400	M5

Connection variants

انواع اتصال

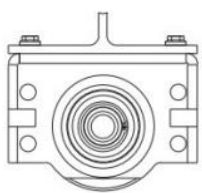

Top Connection

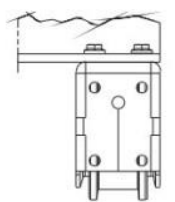

اتصال از بالا

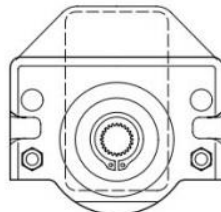

Side Connection

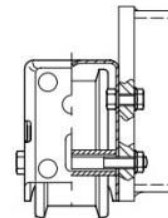

اتصال از کنار

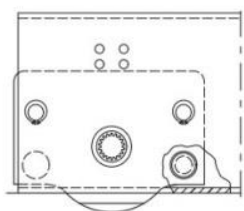

Pin Connection

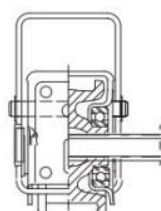

اتصال توسط پین

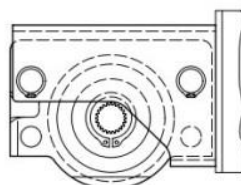

End Connection

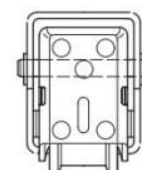

اتصال انتها

